



MODERNO

Tutti gli articoli presenti in questo catalogo sono regolarmente depositati e coperti da brevetti nazionali e internazionali.
All articles in this catalogue are covered by national and international patents.

Copyright©2017 ROBERTO MARELLA S.p.A.

È vietata ogni riproduzione con qualunque mezzo, senza preventiva autorizzazione scritta da parte di Roberto Marella S.p.A.
Ogni trasgressione sarà punita a norma di legge. Marella Design è un marchio commerciale registrato di proprietà Roberto Marella S.p.A.

No parts of this work may be reproduced or copied in any way or by any means, without written permission from Roberto Marella S.p.A. Violators will be prosecuted. Marella Design is a registered trademark of Roberto Marella S.p.A.



MODERNO

RM

*Una storia
consolidata
nel tempo*

MARELLA



In ROBERTO MARELLA S.p.A. la maniglia rappresenta un "luogo particolare". E' un oggetto privilegiato che non si limita ad essere risposta funzionale, ma esprime, nella materia e nella forma, il piacere estetico di un semplice gesto.

ROBERTO MARELLA S.p.A. mantiene e sviluppa una Leadership sul mercato nazionale e internazionale, diventando l'unica azienda italiana con una produzione **100% Made in Italy**, completa e specializzata nella produzione di maniglie e accessori per cucina, bagno e mobile, con un'ampia gamma prodotto sempre più completa in stile e design.

In ROBERTO MARELLA S.p.A., the handle represents this "particular place". It's a privileged object, not only a functional response, it represents, in its features, the esthetical pleasure of a simple gesture.

*ROBERTO MARELLA S.p.A maintains and develops the Leadership on National and International market, becoming the only Italian company with a **completely 100% Made in Italy** production process, complete and specialized in the production of handles and accessories for kitchens, bathrooms and furniture, with a wide range of products even more complete in Style and Design.*



MARCO BORTOLIN

Terminati gli studi di arredamento e di interior design, matura esperienze nel campo del design industriale in qualità di designer ed art director nel mercato italiano, negli Stati Uniti ed attualmente anche nel mercato Russo. In collaborazione con Roberto Marella ha creato una nuova linea di maniglie moderne a marchio Marella Design, in cui emerge tutta la sua abilità artistica e l'eccellenza del Made in Italy, simbolo di qualità, ricerca, innovazione e originalità. *Upon graduation in interior design, he acquired experience in the field of industrial design as designer and art director in Italy, as well as in the United States and, currently, also in the Russian market. In collaboration with Bosetti Marella, he has created a new collection of modern handles, branded Marella Design, where he shows all his artistic skills and the excellence of Made in Italy, symbol of quality, research, innovation and originality.*

GHEORG SEEBACHER

“La curiosità è alla base della comprensione; è perciò essenziale vedere le persone come utilizzatori finali. Dobbiamo cercare di capire i loro valori, contesti culturali e le loro richieste, come future possibilità tecnologiche e collegare, infine, tutti questi aspetti. Attraverso questa comprensione, aspiro, con passione, a sviluppare concetti e implementarli, creando prodotti affascinanti in grado di soddisfare tanto le richieste emozionali quanto quelle funzionali.” *“Curiosity forms the basis of understanding. It is therefore essential to see people as users. We must seek to understand their values, cultural backgrounds, and demands as future technological possibilities and also connect all of these aspects. With this understanding, I passionately aspire to develop concepts and to implement them by creating fascinating products that meet emotional as well as functional requirements.”*

BALUTTO STUDIO

Un atelier in continuo fermento, laboratorio creativo ed officina di produzione, Fondato da Adriano Balutto, più volte nominato -“designer di best seller”-, si è arricchito da qualche anno di un nuovo apporto creativo, l'Arch. Veronica Balutto. L'attività dello studio Balutto è stata premiata svariate volte con prestigiosi riconoscimenti a livello internazionale. *Studio Balutto, an ever moving, creative lab and production workshop. Adriano Balutto is the founder and has been appointed as “Designer of Bestseller” several times; For some years, the new presence of the Architect Veronica Balutto, conveyed a new creative contribution. The Balutto atelier activity has been awarded several times with prestigious international identification.*

ALESSANDRO ELLI

Nasce in Brianza nel 1968, dopo il diploma, frequenta la SPD di Milano seguendo il Master in Disegno Industriale. Le aziende con cui collabora o ha collaborato sono: Axil, Bross, Di Liddo & Perego, Emme-mobili, I Carraro, Linfa, Nespoli - Consonni, Salcon imbottiti, Servetto, Pamar, YDF, Thre. La collezione Cubik progettata per Di Liddo & Perego vince il “premio speciale Tiziana Mascheroni” nell'ambito del concorso Yung & Design 2005. *Was born in Brianza in 1968, after the diploma, attended the SPD in Milan following the Master in Industrial Design. The companies with which it collaborates or has collaborated are: Axil, Bross, Di Liddo & Perego, Emme-mobili, I Carraro, Linfa, Nespoli - Consonni, Salcon imbottiti, Servetto, Pamar, YDF, thre. The Cubik collection designed for Di Liddo & Perego won the “Special Award Tiziana Mascheroni” within the Yung & Design 2005 contest.creativity.*

MICHELE FAINI

“In uno scenario sempre più competitivo nella ricerca, ma appiattito nel gusto, cerco di riportare i miei progetti alle radici della nostra cultura. Il mio obiettivo è soddisfare un bisogno, tenendo conto della ricerca del bello, dell'armonia e dell'estetica, unite alla funzionalità e all'utilità. Siamo geneticamente padroni di fascino ed eleganza, grazie a secoli di fastosa cultura artistica posta agli apici del mondo: la capacità di voltarsi indietro per andare avanti è, a mio parere, la marcia in più che porta a nuove strade di creatività pura.” *“In a period, increasingly competitive in the research, but flattened in the style, I try to bring my projects to the roots of our culture. My goal is to satisfy a need, taking into consideration the research of beauty, harmony and aesthetics, combined with the functionality and usefulness of products. Thanks to our artistic culture placed at the apex of the world, We are genetically owners of charm and elegance: The ability to look back, for going on, is, in my opinion, the extra edge leading to new avenues of pure creativity.”*

TONDA



DESIGN: MARCO BORTOLIN

Serie realizzabile in tutte le finiture indicate a catalogo / Series available in all finishes in the catalogue.

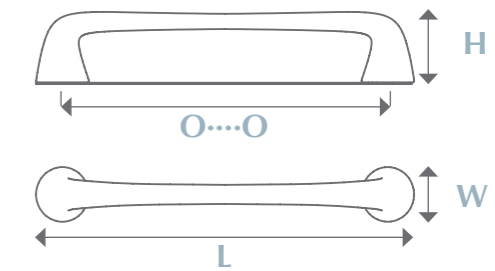

15216Z1600M

L. 184 W. 27 H. 35
O...O 160



15216Z3200M

L. 344 W. 27 H. 35
O...O 320

Finiture illustrate/ Illustrated finishes:
34 NICKEL SATINATO / SATIN NICKEL INOX ASPECT
36 CROMO LUCIDO / BRIGHT CHROME

Materiale/Material: ZAMA - ZAMAK

Maniglie realizzabili nelle finiture illustrate a fine catalogo.
Handles available in the finishes presented at the end of the catalogue.



M.8



M.9

DEFÈNCE

DESIGN: ALESSANDRO ELLI



Serie realizzabile in tutte le finiture indicate a catalogo / Series available in all finishes in the catalogue.

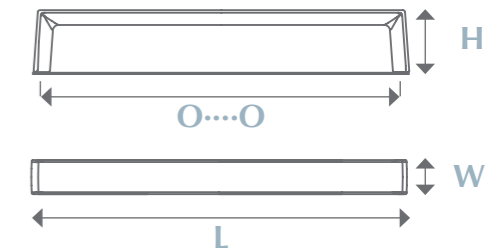

15210Z0960M

L. 103 W. 16 H. 28
O...O 96



15210Z1600M

L. 167 W. 16 H. 28
O...O 160



15210Z3200M

L. 327 W. 16 H. 28
O...O 320

Finiture illustrate/ Illustrated finishes:
34 NICKEL SATINATO / SATIN NICKEL INOX ASPECT
36 CROMO LUCIDO / BRIGHT CHROME

Materiale/ Material: ZAMA - ZAMAK

Maniglie realizzabili nelle finiture illustrate a fine catalogo.
Handles available in the finishes presented at the end of the catalogue.



M.12



M.13

LAMA

DESIGN: MARCO BORTOLIN



Serie realizzabile in tutte le finiture indicate a catalogo / Series available in all finishes in the catalogue.

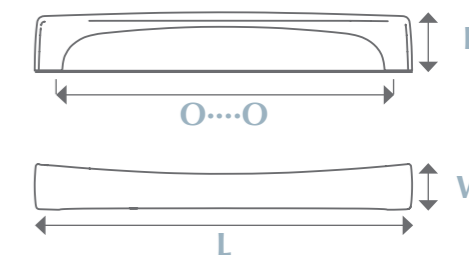

15206Z1600M

L. 170 W. 20 H. 26
O...O 160



15206Z3200M

L. 330 W. 20 H. 26
O...O 320

Finiture illustrate/ Illustrated finishes:
34 NICKEL SATINATO / SATIN NICKEL INOX ASPECT
36 CROMO LUCIDO / BRIGHT CHROME

Materiale/Material: ZAMA - ZAMAK

Maniglie realizzabili nelle finiture illustrate a fine catalogo.
Handles available in the finishes presented at the end of the catalogue.



M.16



M.17



M.18



M.19

CLIP

DESIGN: MARCO BORTOLIN



Serie realizzabile in tutte le finiture indicate a catalogo / Series available in all finishes in the catalogue.



15243Z0960M

L. 108 W. 13 H. 29
O...O 96



15243Z1600M

L. 172 W. 13 H. 29
O...O 160

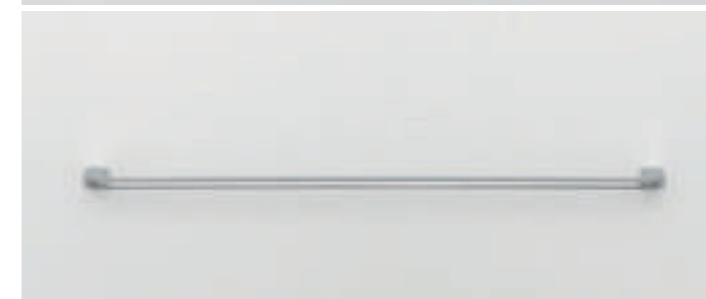

15243Z3200M

L. 332 W. 13 H. 29
O...O 320

Finiture illustrate/ Illustrated finishes:
34 NICKEL SATINATO / SATIN NICKEL INOX ASPECT
36 CROMO LUCIDO / BRIGHT CHROME

Materiale/Material: ZAMA - ZAMAK

Maniglie realizzabili nelle finiture illustrate a fine catalogo.
Handles available in the finishes presented at the end of the catalogue.



M.22



M.23



M.24



M.25



COLIBRÌ

DESIGN: MARCO BORTOLIN



Serie realizzabile in tutte le finiture indicate a catalogo / Series available in all finishes in the catalogue.

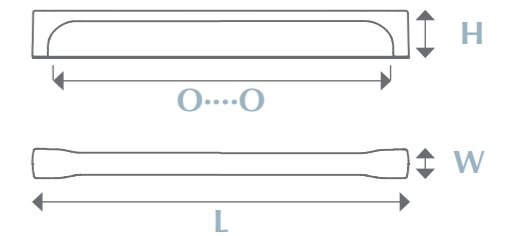

15244Z1600M

L. 170 W. 18 H. 29
O...O 160



15244Z2240M

L. 233 W. 18 H. 29
O...O 224

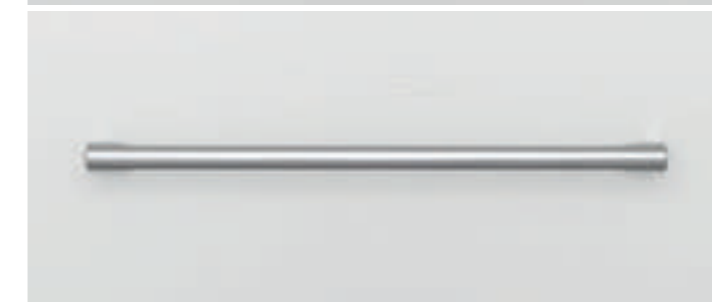

15244Z3200M

L. 330 W. 18 H. 29
O...O 320

LIBRA



24180Z0190M

L. 19 W. 19 H. 22

Finiture illustrate/ Illustrated finishes:
34 NICKEL SATINATO / SATIN NICKEL INOX ASPECT
36 CROMO LUCIDO / BRIGHT CHROME

Materiale/Material: ZAMA - ZAMAK

Maniglie realizzabili nelle finiture illustrate a fine catalogo.
Handles available in the finishes presented at the end of the catalogue.



M.28

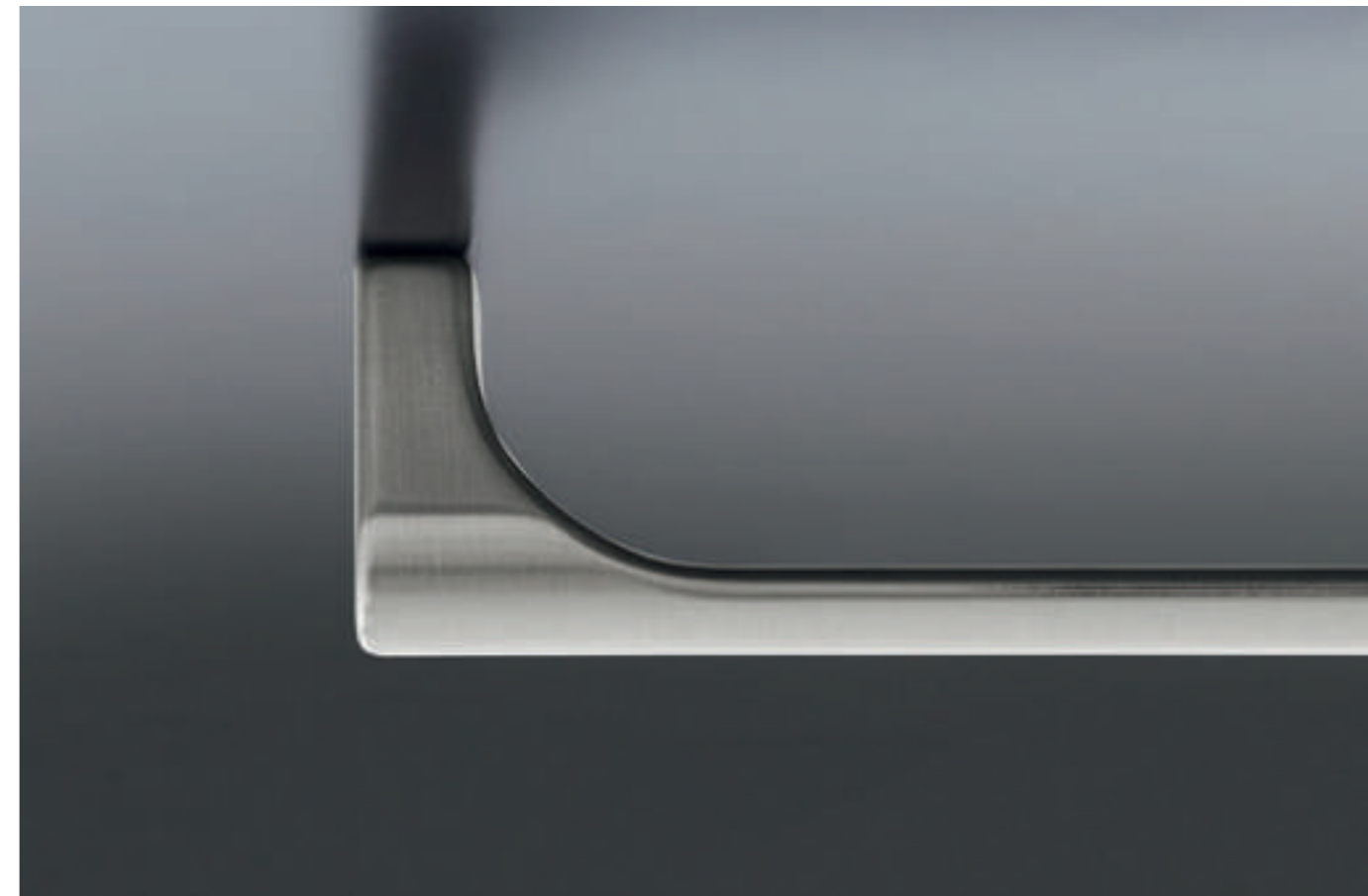

M.29

APPENDIABITI/HOOKS



Serie realizzabile in tutte le finiture indicate a catalogo / Series available in all finishes in the catalogue.

DESIGN: MARCO BORTOLIN

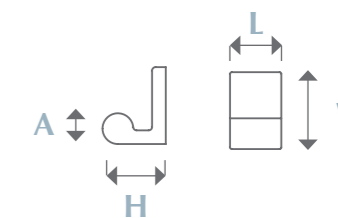

43244Z0450M

L. 30 W. 45 H. 37
A. 18

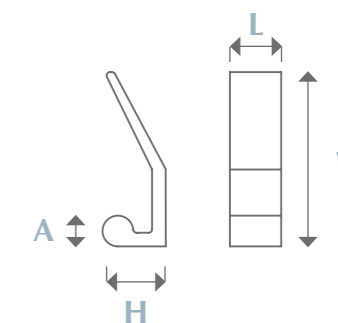

43244Z1020M

L. 30 W. 102 H. 37
A. 18

Finiture illustrate/ Illustrated finishes:
34 NICKEL SATINATO / SATIN NICKEL INOX ASPECT
36 CROMO LUCIDO / BRIGHT CHROME

Materiale/Material: ZAMA - ZAMAK

Maniglie realizzabili nelle finiture illustrate a fine catalogo.
Handles available in the finishes presented at the end of the catalogue.



OSAKA

DESIGN: BALUTTO ASSOCIATI STUDIO



Serie realizzabile in tutte le finiture indicate a catalogo / Series available in all finishes in the catalogue.

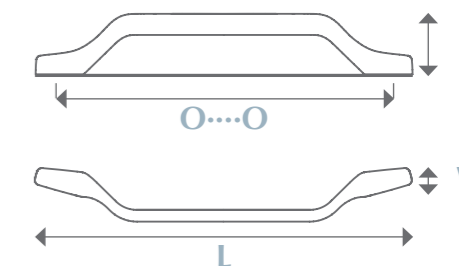

15205Z0960M

L. 127 W.27 H.31
O...O 96



15205Z1600M

L. 191 W. 27 H. 31
O...O 160

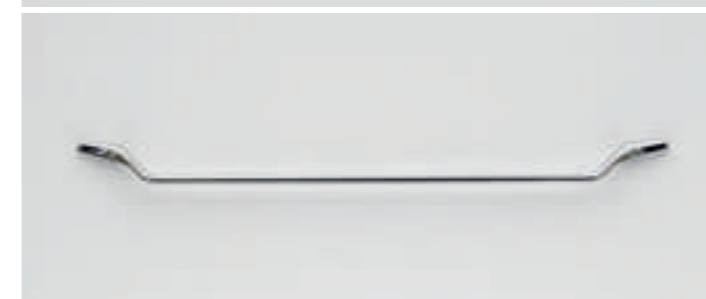

15205Z3200M

L. 351 W. 27 H. 31
O...O 320

Finiture illustrate/ Illustrated finishes:
34 NICKEL SATINATO / SATIN NICKEL INOX ASPECT
36 CROMO LUCIDO / BRIGHT CHROME

Materiale/Material: ZAMA - ZAMAK

Maniglie realizzabili nelle finiture illustrate a fine catalogo.
Handles available in the finishes presented at the end of the catalogue.



M.34



M.35



M.36

M.37



FRIDA

DESIGN: MARELLA DESIGN LAB



Serie realizzabile in tutte le finiture indicate a catalogo / Series available in all finishes in the catalogue.

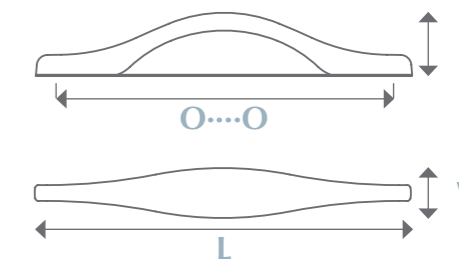

15098Z16020

L. 210 W. 28 H. 35
O...O 160-128



15098Z22420

L. 250 W. 31 H. 39
O...O 224-160

Finiture illustrate/ Illustrated finishes:
34 NICKEL SATINATO / SATIN NICKEL INOX ASPECT
36 CROMO LUCIDO / BRIGHT CHROME

Materiale/Material: ZAMA - ZAMAK

Maniglie realizzabili nelle finiture illustrate a fine catalogo.
Handles available in the finishes presented at the end of the catalogue.



M.40



M.41

FRIDA

DESIGN: MARELLA DESIGN LAB

MARELLA
100% MADE IN ITALY

Serie realizzabile in tutte le finiture indicate a catalogo / Series available in all finishes in the catalogue.



M.42



24488Z04800

L. 48 W. 30 H. 24

Finiture illustrate/ **I**llustrated finishes:
34 NICKEL SATINATO / SATIN NICKEL INOX ASPECT
36 CROMO LUCIDO / BRIGHT CHROME

Materiale/**M**aterial: ZAMA - ZAMAK

Maniglie realizzabili nelle finiture illustrate a fine catalogo.
Handles available in the finishes presented at the end of the catalogue.

M.43

ULTEVANNA

DESIGN: ALESSANDRO ELLI

Serie realizzabile in tutte le finiture indicate a catalogo / Series available in all finishes in the catalogue.



15221Z1700M

L. 170 W. 25 H. 17
A 96
C 13,5
D 166
E 19

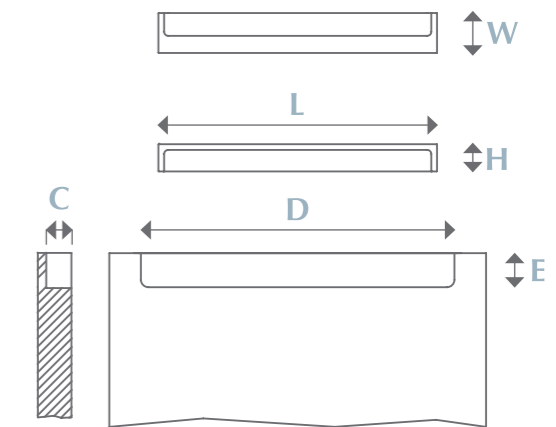

Finiture illustrate/ Illustrated finishes:
45 CROMO OPACO / MAT CHROME
Materiale/Material: ZAMA - ZAMAK

Disponibile disegni tecnici per l'incasso / Technical drawings available for the recession
Per spessori a partire da 16 mm / For thickness above 16 mm



BURGASSER

DESIGN: ALESSANDRO ELLI

Serie realizzabile in tutte le finiture indicate a catalogo / Series available in all finishes in the catalogue.



15220Z1740M

L. 174 W. 45 H. 18
A 128
C 14,5
D 170
E 42

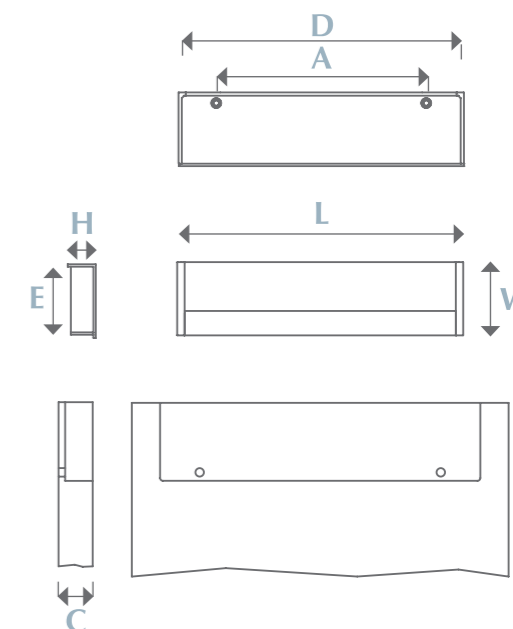

Finiture illustrate/ **I**llustrated finishes:
34 NICKEL SATINATO/ SATIN NICKEL INOX ASPECT

Materiale/**M**aterial: ZAMA - ZAMAK

Maniglie realizzabili nelle finiture illustrate a fine catalogo.
Handles available in the finishes presented at the end of the catalogue.

Disponibile disegni tecnici per l'incasso / **T**echnical drawings available for the recession
Per spessori a partire da 18 mm / **F**or thickness above 18 mm



DURA DURA

DESIGN: ALESSANDRO ELLI

Serie realizzabile in tutte le finiture indicate a catalogo / Series available in all finishes in the catalogue.



15222Z1470M

L.147 W.43 H.16
A 128
C 14
D 141
E 39

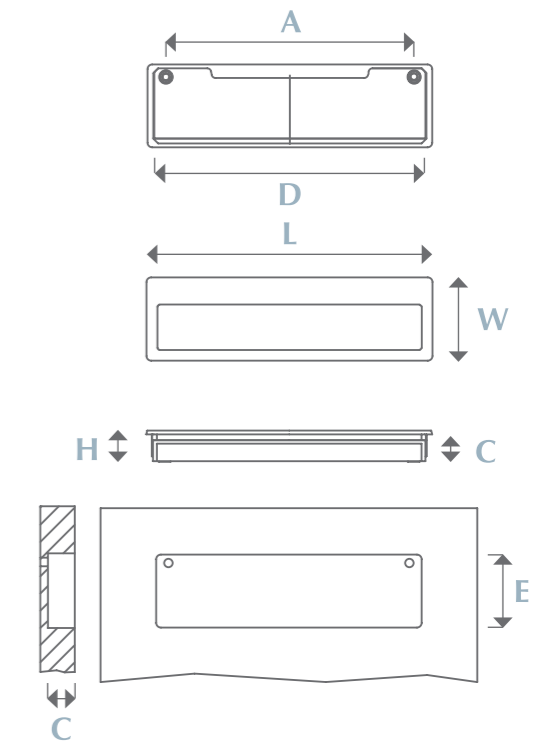

Finiture illustrate/ Illustrated finishes:
34 NICKEL SATINATO/ SATIN NICKEL INOX ASPECT

Materiale/ Material: ZAMA - ZAMAK

Maniglie realizzabili nelle finiture illustrate a fine catalogo.
Handles available in the finishes presented at the end of the catalogue.

Disponibile disegni tecnici per l'incasso / Technical drawings available for the recession
Per spessori a partire da 18 mm / For thickness above 18 mm



DURA DURA

Serie realizzabile in tutte le finiture indicate a catalogo / Series available in all finishes in the catalogue.

DESIGN: ALESSANDRO ELLI



15222Z0600M

L.60 W.60 H. 16
A 32
C 14
D 56
E 54

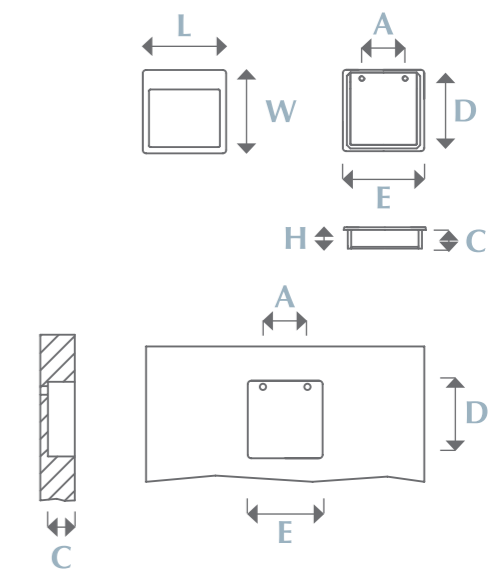

Finiture illustrate/ **I**llustrated finishes:
34 NICKEL SATINATO/ SATIN NICKEL INOX ASPECT

Materiale/**M**aterial: ZAMA - ZAMAK

Maniglie realizzabili nelle finiture illustrate a fine catalogo.
Handles available in the finishes presented at the end of the catalogue.

Disponibile disegni tecnici per l'incasso / **T**echnical drawings available for the recession
Per spessori a partire da 18 mm / **F**or thickness above 18 mm



SINTESI

DESIGN: MARCO BORTOLIN

Serie realizzabile in tutte le finiture indicate a catalogo / Series available in all finishes in the catalogue.

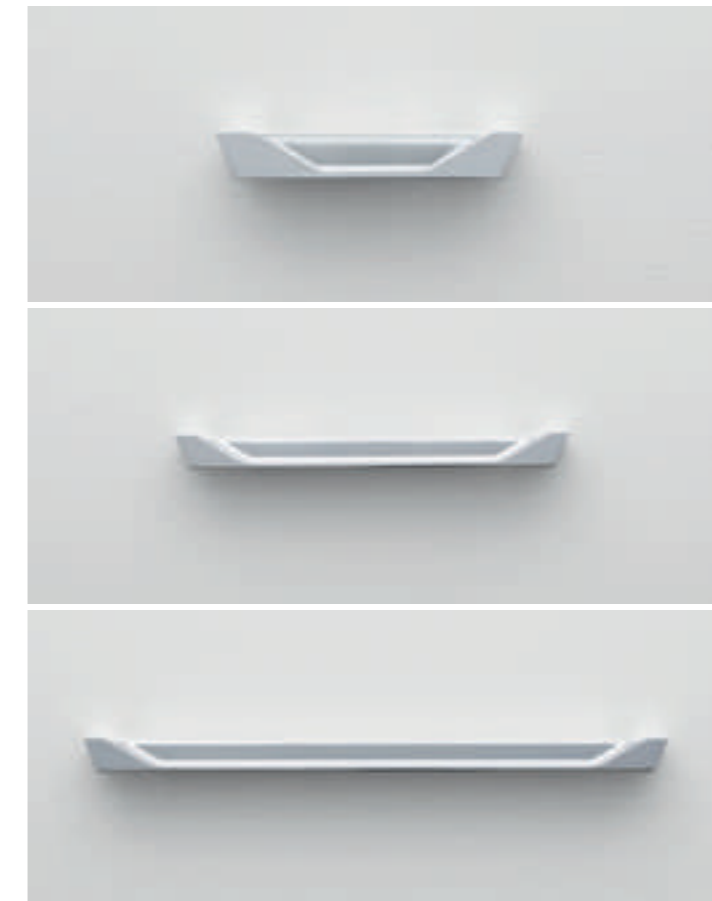

15188Z0320M

L. 110 W. 21 H. 18
A 32
C 14,5
D 90
E 16,5

15188Z1280M

L. 200 W. 20 H. 18
A 128
C 14,5
D 180
E 16,5

15188Z2240M

L. 295 W. 20 H. 18
A 112
C 14,5
D 275
E 16,5

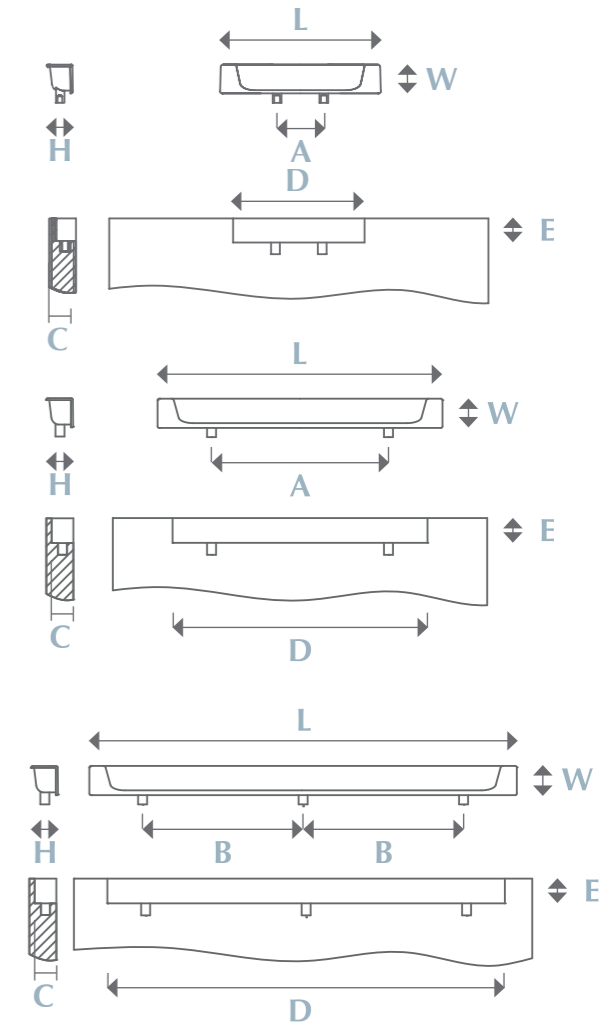

Disponibile disegni tecnici per l'incasso / Technical drawings available for the recession
Per spessori a partire da 18 mm / For thickness above 18 mm

Finiture illustrate/ Illustrated finishes:
45 CROMO OPACO/ MAT CHROME

Materiale/Material: ZAMA - ZAMAK

Maniglie realizzabili nelle finiture illustrate a fine catalogo.
Handles available in the finishes presented at the end of the catalogue.



M.54



M.55



CALEIDO

DESIGN: MARCO BORTOLIN



Serie realizzabile in tutte le finiture indicate a catalogo / Series available in all finishes in the catalogue.

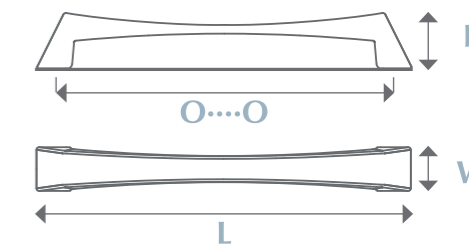

15187Z1280M

L. 150 W. 25 H. 31
O...O 128



15187Z1920M

L. 214 W. 25 H. 32
O...O 192



15187Z3200M

L. 342 W. 25 H. 34
O...O 320

Finiture illustrate/ Illustrated finishes:
34 NICKEL SATINATO / SATIN NICKEL INOX ASPECT
36 CROMO LUCIDO / BRIGHT CHROME

Materiale/Material: ZAMA - ZAMAK

Maniglie realizzabili nelle finiture illustrate a fine catalogo.
Handles available in the finishes presented at the end of the catalogue.



M.58



M.59



CALEIDO

DESIGN: MARCO BORTOLIN



Serie realizzabile in tutte le finiture indicate a catalogo / Series available in all finishes in the catalogue.

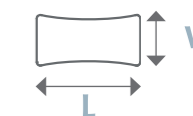

24387Z0430M

L. 43 W. 21 H. 30

Finiture illustrate/ Illustrated finishes:

34 NICKEL SATINATO / SATIN NICKEL INOX ASPECT
36 CROMO LUCIDO / BRIGHT CHROME

Materiale/Material: ZAMA - ZAMAK

Maniglie realizzabili nelle finiture illustrate a fine catalogo.
Handles available in the finishes presented at the end of the catalogue.

M.60

M.61



ONDA

DESIGN: MARCO BORTOLIN



Serie realizzabile in tutte le finiture indicate a catalogo / Series available in all finishes in the catalogue.

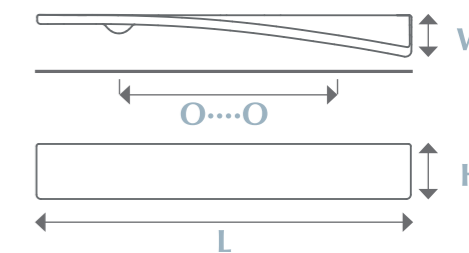

SX · L

DX · R



15182Z064DM - DESTRA/RIGHT
15182Z064SM - SINISTRA/LEFT

L. 110 W. 19 H. 25
O...O 64



15182Z096DM - DESTRA/RIGHT
15182Z096SM - SINISTRA/LEFT

L. 170 W. 19 H. 25
O...O 96



15182Z160DM - DESTRA/RIGHT
15182Z160SM - SINISTRA/LEFT

L. 250 W. 19 H. 25
O...O 160

Finiture illustrate/ Illustrated finishes:
34 NICKEL SATINATO / SATIN NICKEL INOX ASPECT
36 CROMO LUCIDO / BRIGHT CHROME

Materiale/Material: ZAMA - ZAMAK

Maniglie realizzabili nelle finiture illustrate a fine catalogo.
Handles available in the finishes presented at the end of the catalogue.



M.64



M.65

ARCO

DESIGN: MARCO BORTOLIN

Serie realizzabile in tutte le finiture indicate a catalogo / Series available in all finishes in the catalogue.

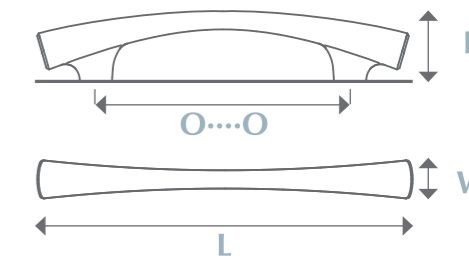

15183Z1280M

L. 185 W. 19 H. 35
O...O 128



15183Z2240M

L. 281 W. 19 H. 35
O...O 224

Finiture illustrate/ Illustrated finishes:
34 NICKEL SATINATO / SATIN NICKEL INOX ASPECT
36 CROMO LUCIDO / BRIGHT CHROME

Materiale/Material: ZAMA - ZAMAK

Maniglie realizzabili nelle finiture illustrate a fine catalogo.
Handles available in the finishes presented at the end of the catalogue.





ARCO

DESIGN: MARCO BORTOLIN



Serie realizzabile in tutte le finiture indicate a catalogo / Series available in all finishes in the catalogue.

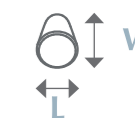

24183Z0200M

L. 20 W. 26 H. 35

Finiture illustrate/ Illustrated finishes:

34 NICKEL SATINATO / SATIN NICKEL INOX ASPECT
36 CROMO LUCIDO / BRIGHT CHROME

Materiale/Material: ZAMA - ZAMAK

Maniglie realizzabili nelle finiture illustrate a fine catalogo.
Handles available in the finishes presented at the end of the catalogue.



M.70

QUADRA

DESIGN: MARCO BORTOLIN



Serie realizzabile in tutte le finiture indicate a catalogo / Series available in all finishes in the catalogue.

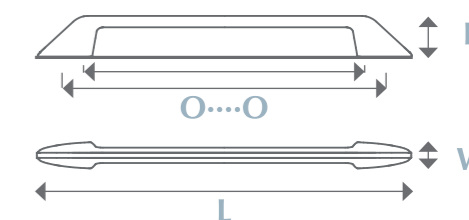

15186Z1602M

L. 193 W. 18 H. 28
O²...O 128-160



15186Z2242M

L. 257 W. 18 H. 28
O²...O 192-224

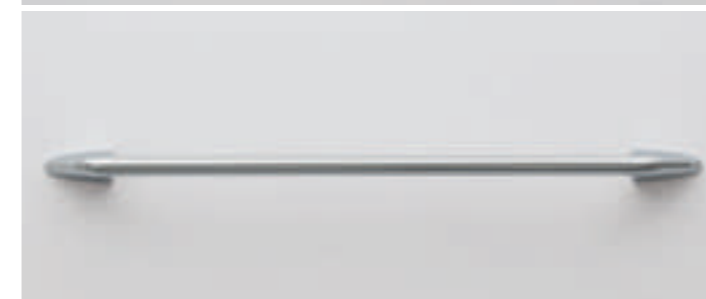

15186Z3202M

L. 353 W. 18 H. 28
O²...O 288-320

Finiture illustrate/ Illustrated finishes:
34 NICKEL SATINATO / SATIN NICKEL INOX ASPECT
36 CROMO LUCIDO / BRIGHT CHROME

Materiale/Material: ZAMA - ZAMAK

Maniglie realizzabili nelle finiture illustrate a fine catalogo.
Handles available in the finishes presented at the end of the catalogue.

M.71



M.72

M.73

QUADRA

DESIGN: MARCO BORTOLIN



Serie realizzabile in tutte le finiture indicate a catalogo / Series available in all finishes in the catalogue.

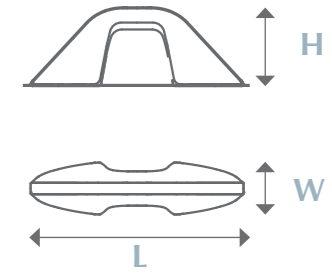

15186Z0320M

L. 65 W. 16 H. 24
O...O 32

Finiture illustrate/ Illustrated finishes:
34 NICKEL SATINATO / SATIN NICKEL INOX ASPECT
36 CROMO LUCIDO / BRIGHT CHROME

Materiale/Material: ZAMA - ZAMAK

Maniglie realizzabili nelle finiture illustrate a fine catalogo.
Handles available in the finishes presented at the end of the catalogue.



VELA

DESIGN: MARCO BORTOLIN



Serie realizzabile in tutte le finiture indicate a catalogo / Series available in all finishes in the catalogue.

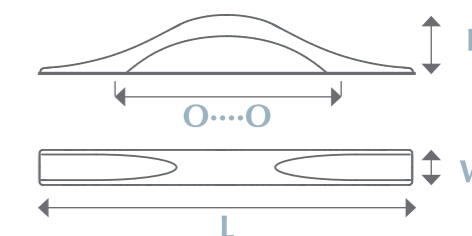

15184Z1280M

L. 218 W. 21 H. 34
O....O 128



15184Z1600M

L. 255 W. 21 H. 35
O....O 160

Finiture illustrate/ Illustrated finishes:
34 NICKEL SATINATO / SATIN NICKEL INOX ASPECT
36 CROMO LUCIDO / BRIGHT CHROME

Materiale/Material: ZAMA - ZAMAK

Maniglie realizzabili nelle finiture illustrate a fine catalogo.
Handles available in the finishes presented at the end of the catalogue.



M.78



M.79

VELA

DESIGN: MARCO BORTOLIN



Serie realizzabile in tutte le finiture indicate a catalogo / Series available in all finishes in the catalogue.

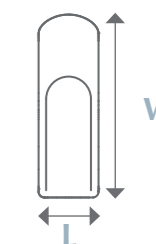

15184Z0320M

L. 21 W. 63 H. 21
O...O 32

Finiture illustrate/ Illustrated finishes:
34 NICKEL SATINATO / SATIN NICKEL INOX ASPECT
36 CROMO LUCIDO / BRIGHT CHROME

Materiale/Material: ZAMA - ZAMAK

Maniglie realizzabili nelle finiture illustrate a fine catalogo.
Handles available in the finishes presented at the end of the catalogue.



M.82



M.83



CALIPSO

DESIGN: MARCO BORTOLIN



Serie realizzabile in tutte le finiture indicate a catalogo / Series available in all finishes in the catalogue.

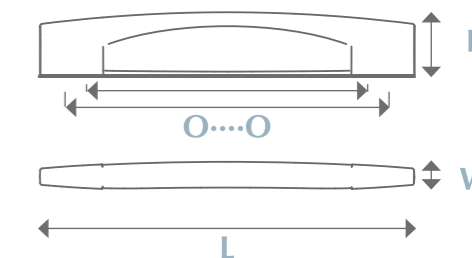

15189Z1602M

L. 180 W. 13 H. 30
O²...O 128-160



15189Z2242M

L. 244 W. 13 H. 30
O²...O 192-224

Finiture illustrate/ Illustrated finishes:
34 NICKEL SATINATO / SATIN NICKEL INOX ASPECT
36 CROMO LUCIDO / BRIGHT CHROME

Materiale/Material: ZAMA - ZAMAK

Maniglie realizzabili nelle finiture illustrate a fine catalogo.
Handles available in the finishes presented at the end of the catalogue.



M.86



M.87

CALIPSO

DESIGN: MARCO BORTOLIN

Serie realizzabile in tutte le finiture indicate a catalogo / Series available in all finishes in the catalogue.

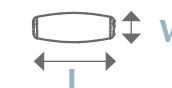

24189Z0300M

L. 30 W. 11 H. 25

Finiture illustrate/ Illustrated finishes:
34 NICKEL SATINATO / SATIN NICKEL INOX ASPECT
36 CROMO LUCIDO / BRIGHT CHROME

Materiale/Material: ZAMA - ZAMAK

Maniglie realizzabili nelle finiture illustrate a fine catalogo.
Handles available in the finishes presented at the end of the catalogue.



LINEA

DESIGN: MARCO BORTOLIN



Serie realizzabile in tutte le finiture indicate a catalogo / Series available in all finishes in the catalogue.

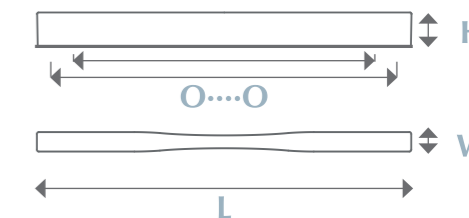

15073Z0642M

L. 76 W. 10 H. 18
O²...O 32-64



15073Z1282M

L. 140 W. 10 H. 18
O²...O 96-128



15073Z1922M

L. 204 W. 10 H. 18
O²...O 160-192



15073Z2562M

L. 268 W. 10 H. 18
O²...O 224-256

Finiture illustrate/ Illustrated finishes:
34 NICKEL SATINATO / SATIN NICKEL INOX ASPECT
36 CROMO LUCIDO / BRIGHT CHROME

Materiale/Material: ZAMA - ZAMAK

Maniglie realizzabili nelle finiture illustrate a fine catalogo.
Handles available in the finishes presented at the end of the catalogue.

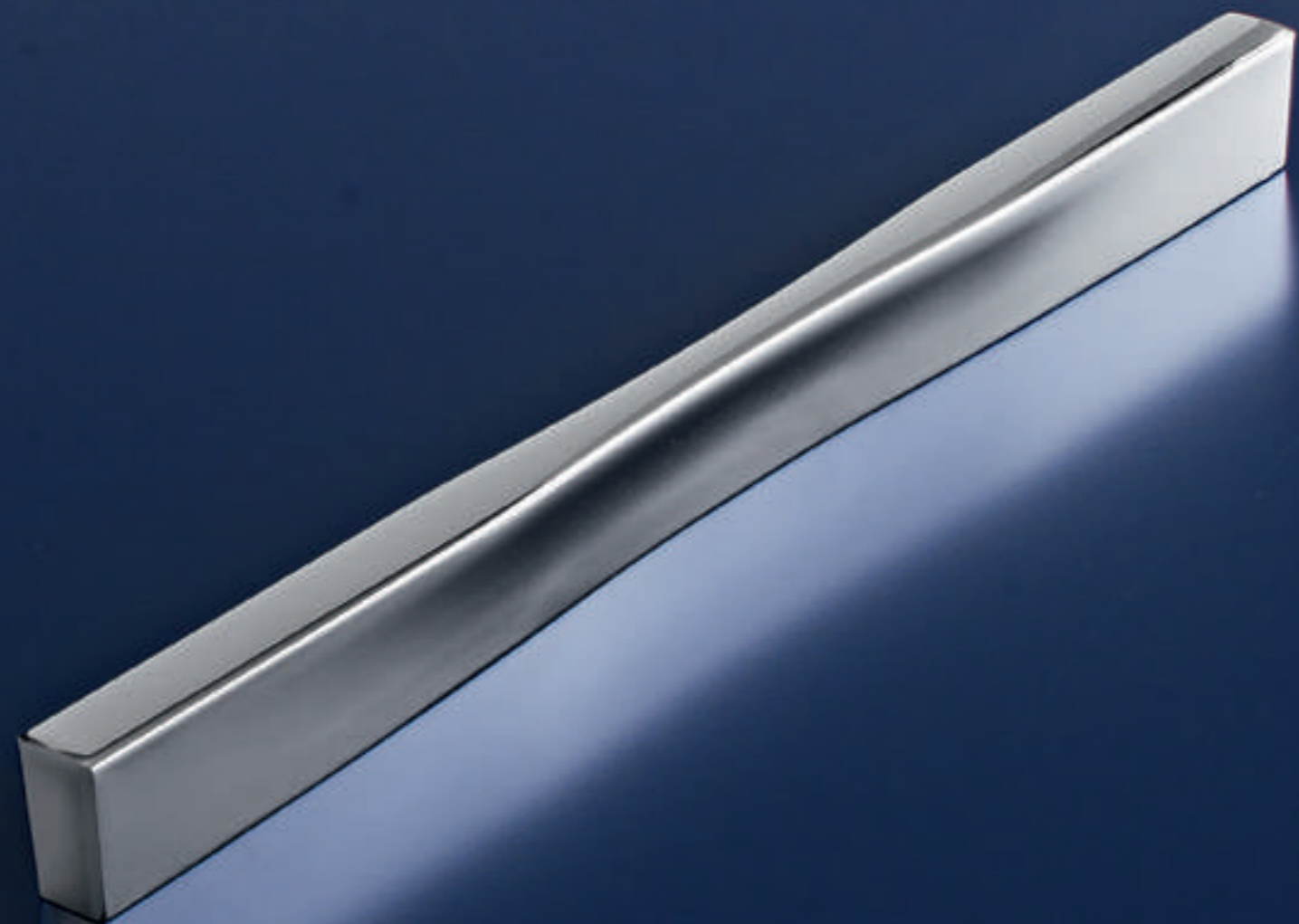

M.92



M.93



M.94

REGATA

DESIGN: MARCO BORTOLIN



Serie realizzabile in tutte le finiture indicate a catalogo / Series available in all finishes in the catalogue.

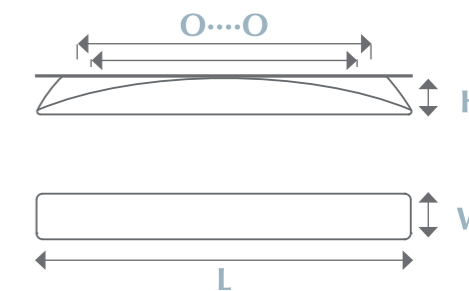

15181Z0960M

L. 157 W. 31 H. 25
O...O 96



15181Z1922M

L. 246 W. 31 H. 25
O...O² 160 - 192

Finiture illustrate/ Illustrated finishes:
34 NICKEL SATINATO / SATIN NICKEL INOX ASPECT
36 CROMO LUCIDO / BRIGHT CHROME

Materiale/Material: ZAMA - ZAMAK

Maniglie realizzabili nelle finiture illustrate a fine catalogo.
Handles available in the finishes presented at the end of the catalogue.

M.95



M.96



M.97



REGATA

DESIGN: MARCO BORTOLIN



Serie realizzabile in tutte le finiture indicate a catalogo / Series available in all finishes in the catalogue.

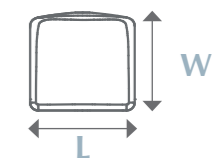
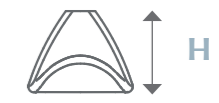

24181Z0320M

L. 32 W. 30 H. 25

Finiture illustrate/ Illustrated finishes:
34 NICKEL SATINATO / SATIN NICKEL INOX ASPECT
36 CROMO LUCIDO / BRIGHT CHROME

Materiale/Material: ZAMA - ZAMAK

Maniglie realizzabili nelle finiture illustrate a fine catalogo.
Handles available in the finishes presented at the end of the catalogue.



M.100



M.101

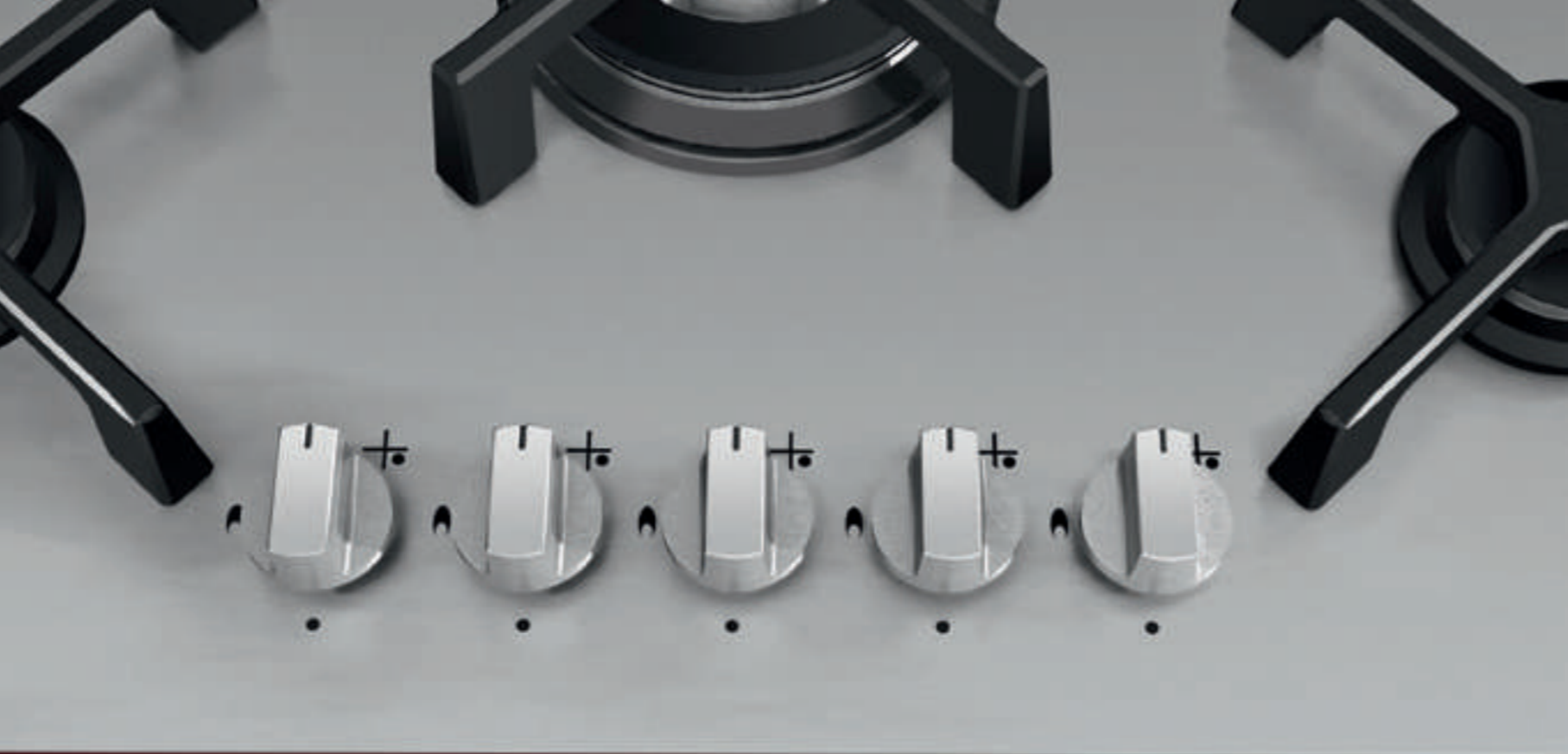

LIBRA

DESIGN: MARCO BORTOLIN



Serie realizzabile in tutte le finiture indicate a catalogo / Series available in all finishes in the catalogue.

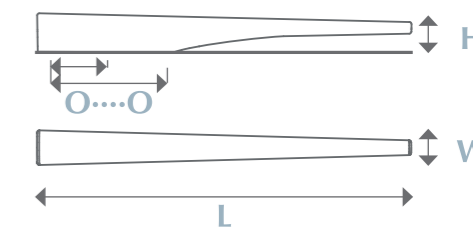

15180Z0320M

L. 130 W. 19 H. 22
O...O 32



15180Z0642M

L. 210 W. 19 H. 22
O²...O 32-64



15180Z0962M

L. 280 W. 19 H. 22
O²...O 64-96

Finiture illustrate/ Illustrated finishes:
34 NICKEL SATINATO / SATIN NICKEL INOX ASPECT
36 CROMO LUCIDO / BRIGHT CHROME

Materiale/Material: ZAMA - ZAMAK

Maniglie realizzabili nelle finiture illustrate a fine catalogo.
Handles available in the finishes presented at the end of the catalogue.





M.104

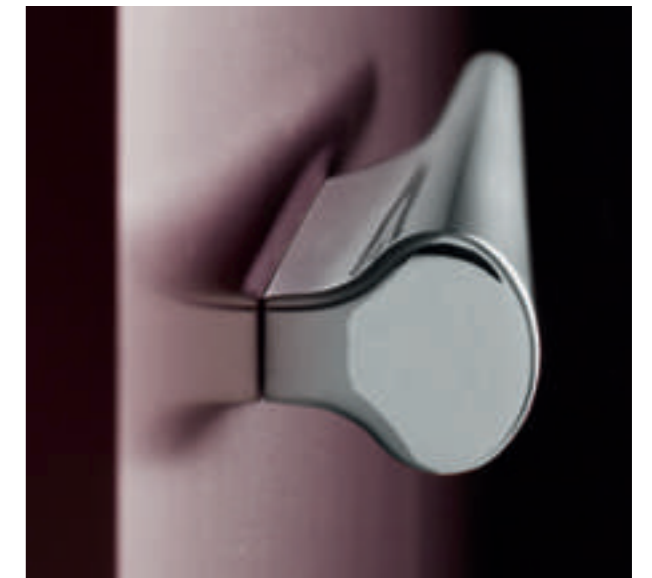

M.105

LIBRA



Serie realizzabile in tutte le finiture indicate a catalogo / Series available in all finishes in the catalogue.

DESIGN: MARCO BORTOLIN

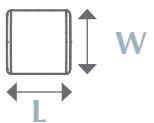
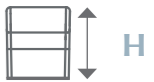

24180Z0190M

L. 19 W. 19 H. 22

Finiture illustrate/ Illustrated finishes:

34 NICKEL SATINATO / SATIN NICKEL INOX ASPECT
36 CROMO LUCIDO / BRIGHT CHROME

Materiale/Material: ZAMA - ZAMAK

Maniglie realizzabili nelle finiture illustrate a fine catalogo.
Handles available in the finishes presented at the end of the catalogue.



MUSA

DESIGN: MARCO BORTOLIN



Serie realizzabile in tutte le finiture indicate a catalogo / Series available in all finishes in the catalogue.

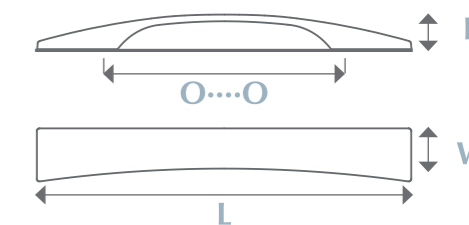

15185Z1280M

L. 210 W. 30 H. 19
O...O 128



15185Z1600M

L. 247 W. 30 H. 19
O...O 160

Finiture illustrate/ Illustrated finishes:
34 NICKEL SATINATO / SATIN NICKEL INOX ASPECT
36 CROMO LUCIDO / BRIGHT CHROME

Materiale/Material: ZAMA - ZAMAK

Maniglie realizzabili nelle finiture illustrate a fine catalogo.
Handles available in the finishes presented at the end of the catalogue.





M.110



M.111

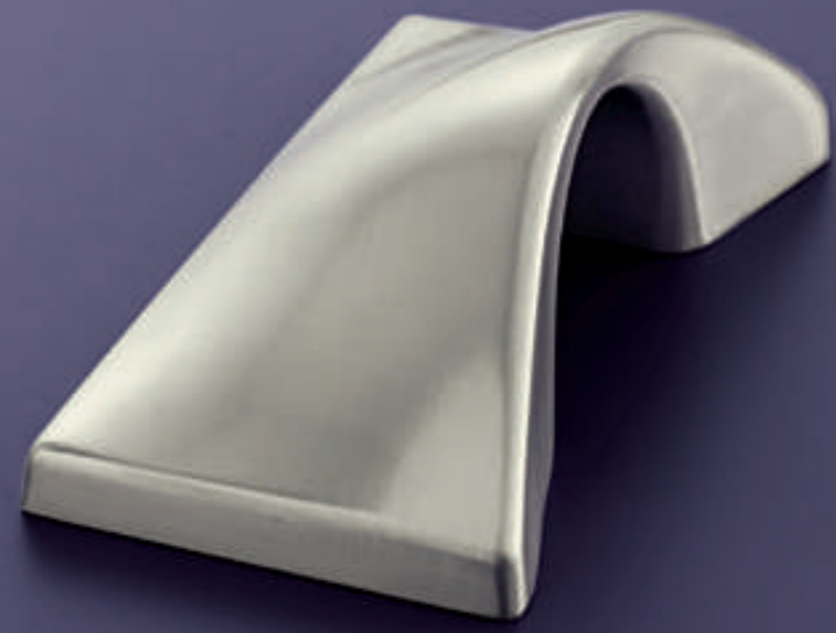

MUSA

DESIGN: MARCO BORTOLIN



Serie realizzabile in tutte le finiture indicate a catalogo / Series available in all finishes in the catalogue.

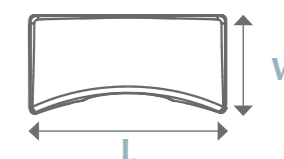

15185Z0320M

L. 60 W. 30 H. 19
O...O 32

Finiture illustrate/ Illustrated finishes:
34 NICKEL SATINATO / SATIN NICKEL INOX ASPECT
36 CROMO LUCIDO / BRIGHT CHROME

Materiale/Material: ZAMA - ZAMAK

Maniglie realizzabili nelle finiture illustrate a fine catalogo.
Handles available in the finishes presented at the end of the catalogue.

ISPIRAZIONE

INDUSTRIAL

Il gusto industrial incontra il design; maniglie moderne, declinate in finiture dallo stile vintage.

L'abbinamento a materiali naturali quali Legno, acciaio e vetro, danno l'idea di ambienti vissuti e d'ispirazione industriale.

The industrial mood meets design elements; Modern handles, available in finishes characterized by vintage style.

The combination of natural materials such as wood, steel and glass, gives the feeling of lived environments and industrial inspiration.



05 BRUNITO
BURNISHED

Finitura di grande impatto emozionale, dal colore caldo e dall'aspetto vintage che dona un particolare effetto materico.

Finish with great emotional impact, with warm and vintage look that gives a particular material effect.



87 OLD FACTORY

La finitura Old factory, dal carattere tradizionale e un pizzico retrò, richiama i colori grigi delle vecchie officine. Ideale abbinata a materiali quali legno e acciaio, così come a colori naturali e tenui.

Old factory finish, a traditional and a bit retro mood that recalls the gray colors of the old laboratories. Ideal combined with materials such as wood and steel, as well as natural and soft colors.



91 PEWTER

La finitura Pewter, dall'effetto grezzo e dai toni grigi, rievoca i vecchi accessori dei casolari di campagna. L'abbinamento a materiali naturali quali legno, acciaio e vetro, danno l'idea di ambienti vissuti e d'ispirazione industriale.

The Pewter finish, the raw effect and gray tones, reminiscent of the old equipment of country cottages. The combination with natural materials such as wood, steel and glass, gives the feeling of lived environments and industrial inspiration.



92 DECAPÉ

La finitura decapé richiama toni sfumati dall'effetto vissuto e graffiato, per ambienti che rievocano lo stile vintage.

The decapé color recalls the shaded tones characterized by the lived and scratched effect, ideal for environments that evoke vintage style.



94 IRON EFFECT

La finitura Iron effect richiama l'idea del ferro graffiato, l'effetto ricorda le officine meccaniche caratterizzate da un marcato stile industriale. Ideale abbinata a materiali naturali quali legno e acciaio.

The Iron effect finish recalls the idea of scratched iron, the effect reminds industrial laboratories and style. It is ideal combined with natural materials such as wood and steel.



95 IRON EFFECT MAT

Iron effect mat, qui proposto nella versione opaca, richiama l'idea del ferro graffiato, il colore ricorda le officine meccaniche caratterizzate da un marcato stile industriale. Ideale abbinata a materiali naturali quali legno e acciaio.

Iron effect mat, here presented in mat version, recalls the idea of scratched iron, the color reminds industrial laboratories and style. It is ideal combined with natural materials such as wood and steel.

TREND INDUSTRIAL

news

MARELLA
100% MADE IN ITALY

TREND INDUSTRIAL

ARCO - 94 IRON EFFECT



FRIDA - 95 IRON EFFECT MAT



FRIDA - 94 IRON EFFECT



LINEA - 95 IRON EFFECT MAT



LINEA - 94 IRON EFFECT



LIBRA - 95 IRON EFFECT MAT





M.118

TREND INDUSTRIAL

news

MARELLA
100% MADE IN ITALY

TREND INDUSTRIAL



MUSA - 87 OLD FACTORY



CALEIDO - 91 PEWTER



ARCO - 87 OLD FACTORY



CLIP - 91 PEWTER



CALEIDO - 87 OLD FACTORY



REGATA - 91 PEWTER

M.119

TREND INDUSTRIAL

news

MARELLA
100% MADE IN ITALY

TREND INDUSTRIAL



M.120



M.121



TREND INDUSTRIAL

news

TREND INDUSTRIAL



FRIDA - 92 DECAPÉ



CALEIDO - 92 DECAPÉ



ARCO - 92 DECAPÉ

ISPIRAZIONE

MATERIC

Finiture dall'effetto materico e dal mood contemporaneo. Colori caldi e sfumature decise che si adattano ad ambienti tradizionali tanto quanto ad ambienti moderni e contemporanei. Effetti che simulano la materia e cercano di fondersi ad essa per offrire stile e personalità. Tutte le vernici utilizzate per questo trend sono vernici all'acqua ed eco-friendly.

Finishes characterized by materic effect and contemporary mood. Warm colors and shades that suit traditional environments as well as modern and contemporary ones. Effects that simulate the matter and blend in with it to offer style and personality. All the paints used for this trend are water-based coatings and eco-friendly.



76 COR-TEN EFFECT

La finitura Cor-ten riproduce l'effetto della naturale ossidazione dell'acciaio Cor-ten, già molto utilizzato in architettura, scultura e nella moda. La finitura ne ricrea il suo vero aspetto materico e tattile dal colore non uniforme e sfumato.

Cor-ten finish reproduces the effect of natural oxidation of steel Cor-ten, already used in architecture, sculpture and fashion. The finish recreates the materic aspect and tactile sensation, maintaining the uneven color and beauty of this color shades.



83 GRAPHITE

La finitura graphite riproduce l'effetto e la colorazione della ghisa, ne ricrea l'aspetto tattile e materico caratterizzato da toni freddi e graffianti. Finitura dall'aspetto innovativo ed elegante.

The graphite finish reproduces the effect and the color of cast iron, it recreates the material aspect and tactile sensation of true cast iron characterized by rough and timeless colors, with an innovative and elegant aspect.



82 KASSITE

La finitura Kassite riproduce l'effetto e la colorazione del bronzo. Colori naturali e sfumature calde legate al colore della terra.

Kassite finish reproduces the effect and colors of Bronze. Natural colors and warm nuances linked to the colors of earth.



85 TITANIUM EFFECT

La finitura titanium effect riproduce l'effetto incisivo e freddo del titanio; il colore grigio satinato, rende questa finitura moderna e di tendenza.

The titanium effect finish reproduces the incisive and cold effect of titanium; the color gray with the satin effect, makes this finish, modern and trendy.



90 TERRA DI SIENA

La finitura Terra di Siena riproduce i colori e le sfumature calde della terra; finitura carica di carattere e personalità in grado di imprimere il proprio stile.

Terra di Siena finish, reproduces warm tones and colors of the earth; Finishing with great character and personality that can make its own style.



98 TOBACCO

Finitura brown dalle nuances leggermente ramate, Tobacco è un colore dall'aspetto materico che richiama i colori naturali della terra.

Finish with slightly brown nuances; Tobacco is a natural-looking and materic color that recalls the natural colors of the earth.



M.126

TREND MATERIC

news

TREND MATERIC

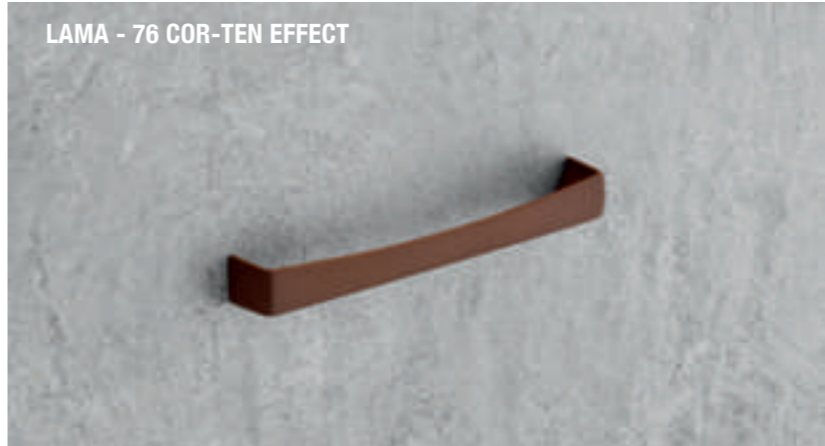

M.127

TREND MATERIC

news

TREND MATERIC



CALIPSO - 82 KASSITE



CALEIDO - 98 TOBACCO



LIBRA - 82 KASSITE



LAMA - 98 TOBACCO



COLIBRÍ - 82 KASSITE



COLIBRÍ - 98 TOBACCO





TREND MATERIC

news

TREND MATERIC

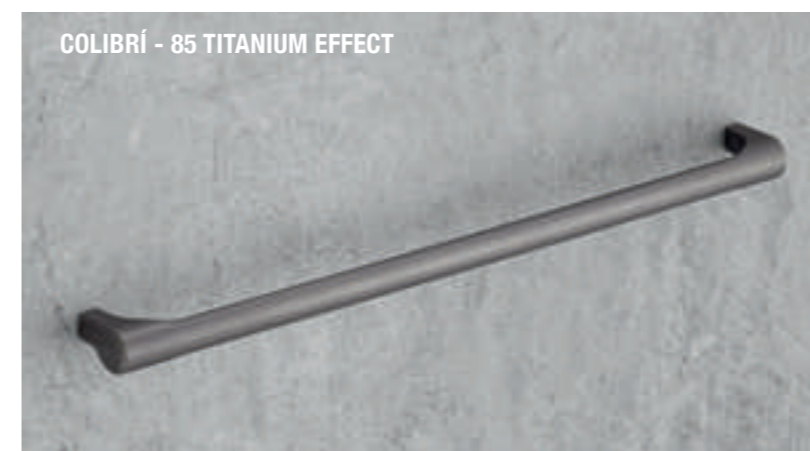
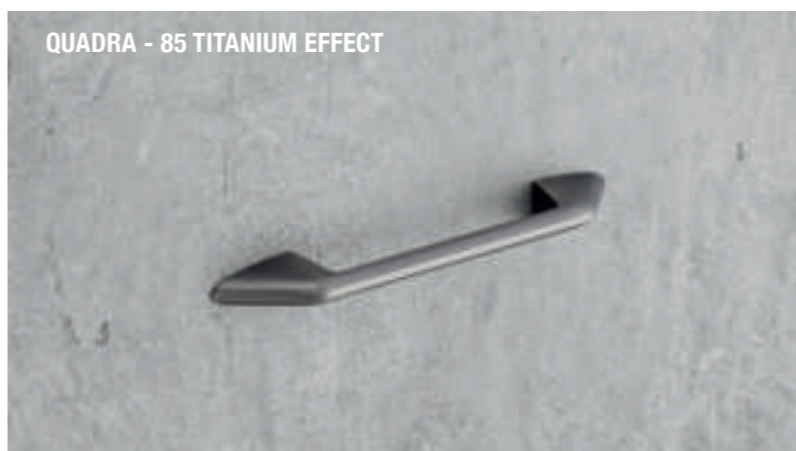

ISPIRAZIONE COPPER

Il rame, materiale antico dal colore caldo e luminoso, viene abbinato a forme lineari e geometriche. Molto elegante, sia nella versione anticata che in quella lucida può prendere parte a diversi stili e può essere accostato a vari materiali.

Copper, old material with warm and bright color, it is combined with linear and geometric shapes. Very elegant, both in the antique version and in the polish one, it can suits different styles and can be matched with various materials.



29 RAMATO ANTICO
ANTIQUÉ COPPER

La finitura ramato antico offre bellezza e personalità, nella versione anticata riporta ad una tradizione passata che si fonde con linee moderne e lineari.

The antique copper finish offers beauty and personality, the antique version bring to a past tradition that blends with modern lines and linear shapes.



23 RAME LUCIDO
BRIGHT COPPER

La finitura rame lucido, brillante e glamour dona interessanti riflessi luminosi. Si adatta ad ambienti dal taglio classico e tradizionale e ad ambienti minimal e di design.

The polish copper finish, brilliant and glamorous, creates interesting light reflections. It adapts to environments with a classic cut and traditional and minimal and design environments.



DC RAME SATINATO
BRUSHED COPPER

La finitura Rame satinato ha un aspetto graffiante e moderno.

Una contaminazione di tonalità ramate, abbinata ad una satinatura che rende l'effetto finale unico e caratteristico.

The brushed copper finish has a scratchy and modern look. A contamination of copper shades, combined with a satin finish that makes the final effect, unique.

TREND MATERIC

news

TREND MATERIC



ARCO - 29 RAMATO ANTICO / ANTIQUE COPPER



CLIP - 23 RAME LUCIDO / BRIGHT COPPER



CALEIDO - 29 RAMATO ANTICO / ANTIQUE COPPER



VELA - 23 RAME LUCIDO / BRIGHT COPPER



OSAKA - 29 RAMATO ANTICO / ANTIQUE COPPER



CALIPSO - 23 RAME LUCIDO / BRIGHT COPPER





M.136

TREND MATERIC

news

TREND MATERIC

LAMA - DC RAME SATINATO / BRUSHED COPPER



ARCO - DC RAME SATINATO / BRUSHED COPPER



COLIBRÍ - DC RAME SATINATO / BRUSHED COPPER



M.137

TREND SPECIAL

news

TREND SPECIAL

ISPIRAZIONE

TREND SPECIAL

Il trend special si articola su 3 tinte: Oro pallido, bronzo ramato e grigio dall'effetto titanio. Si tratta di colorazioni leggermente brillanti che rievocano il glamour degli anni '50. Finiture dalle superfici metalliche, calde e tattili. Si adattano perfettamente ai trend del momento.

The special trend is articulated on 3 different shades: Pale gold, copper bronze and grey like a titanium effect. These are slightly bright colors that recall the glamor of the 1950s. Finishes from metallic surfaces, warm and tactile. They perfectly fit with the trends of the moment.



DG LONDON GREY

Finitura molto elegante, dai toni grigi, simili al colore del titanio opaco. La leggera lucentezza e l'aspetto tattile rendono questa finitura molto elegante e raffinata. Adatta ad ambienti moderni ma anche in abbinamento al legno naturale e caldo.

Very elegant finish, with grey tones, similar to the matte titanium color. Light gloss and tactile appearance make this finish very elegant and refined. Suitable for modern environments but also in combination with natural and warm wood.



DF BRIGHT BRONZE

Una finitura in cui emergono in maniera estremamente bilanciata varie tonalità del bronzo ramato. L'effetto finale, tattile e leggermente luminoso, la rendono elegante e glam.

A finish where bronze and copper shades are extremely balanced. The final result is tactile and slightly bright effect that makes the finish very elegant and glam.



DH GOLDEN SHADOW

Una finitura caratterizzata da una tonalità di oro molto chiara, un colore particolarmente elegante, dalla leggera lucentezza e dai riflessi pallidi ma estremamente glamour.

A finish characterized by a very clear gold tone, a particularly elegant color, light gloss and pale reflections but extremely glamorous.



M.140

TREND SPECIAL

news

TREND SPECIAL



M.141

TREND SPECIAL

news

TREND SPECIAL



M.142



M.143



M.144

TREND SPECIAL

news

TREND SPECIAL



M.145

TREND GOLD

news

TREND GOLD

ISPIRAZIONE

TREND GOLD

Il colore oro, dal fascino magico, elegante e glam, viene proposto nel mondo del design e della moda in mille sfumature e abbinamenti. Le nuance dorate, rendono esclusivo, raffinato e brillante qualsiasi ambiente da quello classico a quello moderno.

The gold color, magical, elegant and glam is offered in the world of design and fashion in a thousand shades and matching. The golden nuances make exclusive, refined and brilliant any environment from the classic to the modern one.



**DS OTTONE
BRASS**

La finitura ottone riproduce il colore dell'ottone, puro, splendente e brillante. Una soluzione dorata molto elegante e raffinata.
The brass finish reproduces the color of the brass, pure, shiny and brilliant. A very elegant and refined golden solution.



**12 OTTONE SATINATO
SATIN BRASS**

La finitura ottone satinato riproduce il colore dell'ottone, contraddistinto però da una satinatura molto caratterizzante che dona luminosità e brillantezza, mantenendo l'eleganza e la raffinatezza del colore dorato.
The satin brass finish reproduces the color of the brass, distinguished by a characteristic satin finish that gives brightness and brilliance, maintaining the elegance and refinement of the golden color.



93 VELVET GOLD

La finitura velvet gold è caratterizzata da un tono caldo dall'effetto opaco e dorato che rende questa finitura molto elegante e raffinata.
The velvet gold finish has a warm tone, the matt effect and gold color, make this finish very elegant and refined.

TREND GOLD

news

TREND GOLD



M.148



M.149



TREND GOLD

news

TREND GOLD



LIBRA - DS OTTONE / BRASS



FRIDA - 12 OTTONE SATINATO / SATIN BRASS



OSAKA - DS OTTONE / BRASS



LAMA - 12 OTTONE SATINATO / SATIN BRASS



ONDA - DS OTTONE / BRASS



ONDA - 12 OTTONE SATINATO / SATIN BRASS



FINITURE STANDARD



STANDARD FINISHES



36 CROMO LUCIDO
BRIGHT CHROME



45 CROMO OPACO
MAT CHROME



34 NICHEL SATINATO
SATIN NICKEL INOX ASPECT



31 NICHEL OPACO
MAT NICKEL



F4 BIANCO LUCIDO
BRIGHT WHITE (RAL 9010)

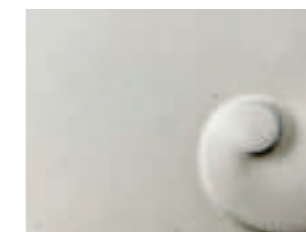

F5 BIANCO OPACO
MAT WHITE (RAL 9010)



N1 NERO LUCIDO
BRIGHT BLACK (RAL 9005)



N2 NERO OPACO
MAT BLACK (RAL 9005)



84 CROMO SATINATO
SATIN CHROME



96 CROMO OPACO
VERNICIATO
MAT CHROME PAINTED



97 NICKEL OPACO
VERNICIATO
MAT NICKEL PAINTED









INDICE/INDEX

CODICE CODE	NOME NAME	PAGINA PAGE
15073Z	Linea	M91
15098Z	Frida	M39
15180Z	Libra	M103
15181Z	Regata	M95
15182Z	Onda	M63
15183Z	Arco	M67
15184Z	Vela	M77-M81
15185Z	Musa	M109-113
15186Z	Quadra	M71-M75
15187Z	Caleido	M57
15188Z	Sintesi	M53
15189Z	Calipso	M85
15205Z	Osaka	M33
15206Z	Lama	M15
15210Z	Dèfence	M11
15216Z	Tonda	M7
15220Z	Brugasser	M47
15221Z	Ultevanna	M45
15222Z	Dura Dura	M49-M51
15243Z	Clip	M21
15244Z	Colibri	M27
24180Z	Libra Pomolo/Knob	M27-M107
24181Z	Regata pomolo/Knob	M99
24183Z	Arco pomolo /Knob	M69
24189Z	Calipso pomolo /Knob	M89
24387Z	Caleido Pomolo/Knob	M61
24488Z	Frida Pomolo/Knob	M43
43244Z	Colibri appendiabiti/Hook	M31

15 | 180 | Z | 064 | 2 | M | 36

- 15 – codice famiglia / family code
 - 15 – maniglia fissa / fixed handle
 - 24 – pomolo / Knob
- 180 – codice modello / model code
- Z – materiale / material
 - Z – Zama / Zamak
- 064 – codice misura / size code
- 2 – variante / variation
 - 2 – doppio interasse / double center hole to center hole
 - 0 – Unico interasse / Unique center hole to center hole
- M – codice identificativo maniglie moderne / code for modern handles
- 36 – codice finitura / finish code

LEGENDA PLUS PRODOTTO / PRODUCT PLUS

	facile applicazione / easy application
	peso sinonimo di qualità / weight: quality plus
	sicurezza, spigoli raggiati / safety: round edges
	ergonomia / ergonomics
	doppio interasse / double center hole to center hole
	orientamento orizzontale-verticale / horizontal and vertical orientation
	buona impugnatura / good hand grip
	per spessori a partire da 18 mm / for thickness above 18 mm

Tutte le misure sono espresse in mm. / All size are in mm.

AVVERTENZE

Roberto Marella S.p.A. si riserva la facoltà di modificare le caratteristiche tecniche dei prodotti a catalogo, in qualunque momento. Per ragioni tecniche, le tonalità dei colori nelle fotografie, possono non rappresentare fedelmente la realtà. Si raccomanda la pulizia con panno umido, evitando l'impiego di detersivi

ATTENTION

Roberto Marella S.p.A. reserves the right to change technical details of products illustrated in this catalogue, whenever necessary. Due to technical reasons, pictures colors could be different from the original colors. We recommend to clean our products with a dry cloth, avoiding the use of detergents or alcohol.



MARELLA

100% MADE IN ITALY

ROBERTO MARELLA S.p.A.

Via Enrico Fermi, 19

25030 Roccafranca fraz. Ludriano (BS) - ITALY

Tel. +39 030 7093111

Fax. +39 030 7093151

E-mail: info@robertomarellaspa.it

www.marelladesign.it